

AE-Y366 Instructions



MOUNTING

1. The thermostat is flush mount; a back box of ideally 45mm depth should be sunk into the wall prior to installation.
2. Choose a location about 5 feet (1.5 meters) above the floor with good air circulation.
3. To avoid electrical shock and to prevent damage to the furnace, air conditioner and thermostat, disconnect the power supply before beginning work. This can be done at the fuse box, at the circuit breaker or at the appliance.

WRING DIAGRAM

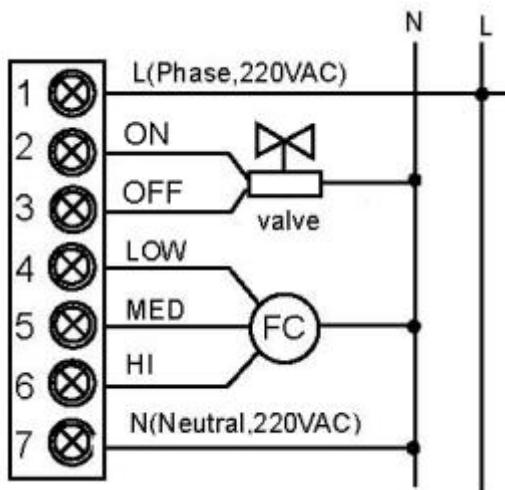

BUTTON EXPLANATION

- “⏻” System on/off
- “⊕” Temperature setting
- “⊖” Idle button
- “⚙️” Fan speed setting
- “△” Increase set value
- “▽” Decrease set value

SPECIFICATIONS

Supply: 220V AC±15% 50/60HZ
Sensing Element: NTC thermistor
Display Accuracy: ±1°C
Mounting hole distance: 60mm (standard)
Connector wire diameter: Max 0.8mm

Set-point Range: 5~35°C
Display: Large Character LCD
Switch Current Rating: < 3A
Housing: Anti-flamed ABS
Dimension: 86*86*13.6mm

STAND BY STATE

When the thermostat is first connected to power, the thermostat will be in stand by state, the LCD displays RT with current room temperature.

System on/off

System on/off can be controlled manually or by timing system. Press  and hold for 5 seconds to activate and stop the system; Display the current room temperature when system off;

System is off when the first electrification. When the thermostat is turned on, the LCD displays:

1. ST(set temperature, this is temperature the thermostat is currently controlling to)
2. RT(room temperature, this is actuator room temp)
3. Time
4. Operating mode, for example:

Heating mode, with icon 

Cooling mode, with icon 

Ventilating mode, icon 

5. fan speed display status, for example,



SETTING CLOCK

When the thermostat is turned on, press  once, time starts flashing, using the up or down key to adjust time.



SETTING TIMER



With timer function, the thermostat can be turned on or off automatically



(A)Timing on setting

Press  once when system on, to enter into the time setting, default time is 12:00, and the setting time starts flashing;

Press  twice when system on, to enter into the timing on setting, default time is 12:00, the time indicator and setting time starts flashing;

Press  to increase time by 1 minute,
Press  and hold to increase time by 5 minutes;



Press  to decrease time by 1 minute,
Press  and hold to decrease time by 5 minutes;



Press other buttons to exit (expect  and ) , the system will exit automatically without any operation in 5 seconds.



(B)Timing off setting

Press  once when system off, to enter into the time setting, default time is 12:00, and the setting time flashing;







Press  twice when system off, to enter into the timing off setting, default time is 12:00, the time indicator and setting time flashing;

Press  to increase time by 1 minute,
Press  and hold to increase time by 5 minutes;

Press  to decrease time by 1 minute,
press  and hold to decrease time by 5 minutes;

Press other buttons to exit (expect  and ) , the system will exit automatically without any operation in 5 seconds.

Temperature setting

Press  or  to adjust the temperature, the flashing default temperature is 22°C;
Press  to increase temperature by 1°C;
Press  to decrease temperature by 1°C;
Press other buttons to exit (expect  and ) , the system will exit automatically without any operation in 5 seconds .

Heating/Cooling setting

Press "" once for heating, twice for cooling when the system on (the default setting is cooling).

Fan speed setting

·3 fan speed, change the fan speed by pressing "" (the default setting is medium).